



EAGLE™

2016



COME TOGETHER
#ITSJAYCO



2
YEAR
WARRANTY



#LETSJAYCO

When you travel with Jayco, fun is the only thing on the agenda. That's because we go the extra mile so you can live in the moment. From comfortable, amenity-packed floorplans to weather-shielding insulation and superior frame construction, you'll have everything you need to adventure every day and make yourself at home every night. Let's get away. Let's make it count. Let's Jayco — and make memories that last a lifetime.

GENERATIONS OF FAMILY FUN



EAGLE

FLEXIBLE FAMILY FUN

With the wide-ranging Eagle lineup, you can bet we've got your type of family fun. From top-of-the-line travel trailers to super-light fifth wheels to full-featured, mid-profile fifth wheels, you'll be relaxing in style—no matter where your trip takes you.



Eagle Travel Trailers: Page 4



Eagle HT Fifth Wheels: Page 8



Eagle Fifth Wheels: Page 12

DISCOVER THE LONGEST-RUNNING, MOST SUCCESSFUL FIFTH WHEEL ON THE MARKET

Our offerings have been among the top five best-selling fifth wheel lines in the U.S. for 20 of the last 25 years

1991 Eagle travel trailer and fifth wheel lines debut

1994 Eagle lightweight series debuts

1997 Eagle becomes the No. 1-selling fifth wheel in the U.S.

2007 Eagle wins its first DSI Award—and has won the award every year since

2008 Jayco celebrates its 40th anniversary; Eagle Half-ton line debuts



DSI award win



SHARE YOUR PHOTOS AND STORIES ON SOCIAL MEDIA WITH [#LETSJAYCO](https://www.instagram.com/letsjayco).



338RETS KITCHEN



8-CUBIC-FOOT REFRIGERATOR

EAGLE TRAVEL TRAILERS

A well-appointed blend of comfort and function, the new Eagle luxury travel trailer lineup is brimming with a list of premium standard features and thoughtful options. Large, residential-sized bedrooms, pantries and showers pair perfectly with standard HDTVs, 8-cubic-foot refrigerators, tri-fold hide-a-bed sofas and solid-surface countertops in 10 exciting floorplans.



338RETS REAR ENTERTAINMENT SYSTEM



338RETS BEDROOM WITH OPTIONAL KING-SIZED DENVER MATTRESS®



338RETS INTERIOR SHOWN IN HAVANA DÉCOR



338RETS BATHROOM



314BHDS BUNKHOUSE

EAGLE TRAVEL TRAILER FLOORPLANS

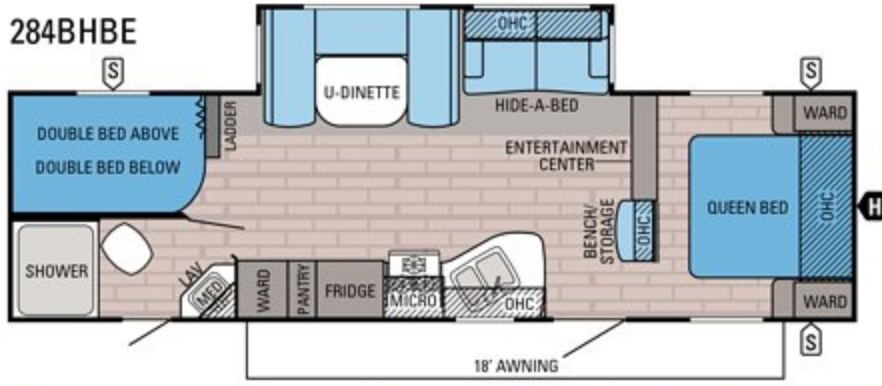

EAGLE TRAVEL TRAILER | 284BHBE OPTION A
Ext. Length: 33' 11" Ext. Height: 137" Unloaded Wt. (lbs.): 7,015 Sleeps: 8-10

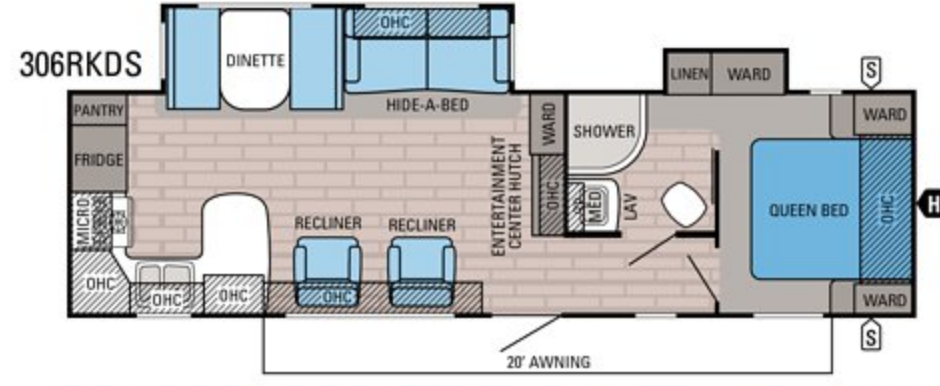

EAGLE TRAVEL TRAILER | 306RKDS OPTIONS: A, B
Ext. Length: 34' 5" Ext. Height: 140" Unloaded Wt. (lbs.): 7,535 Sleeps: 4-7

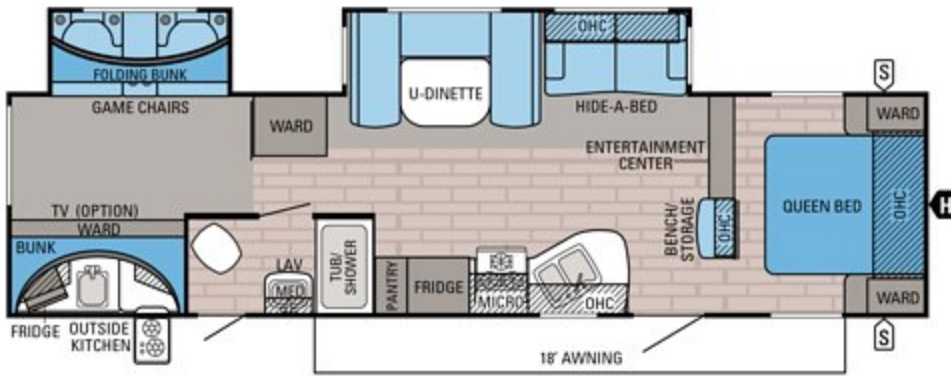

EAGLE TRAVEL TRAILER | 314BHDS OPTION A
Ext. Length: 37' 3" Ext. Height: 137" Unloaded Wt. (lbs.): 8,110 Sleeps: 7-9

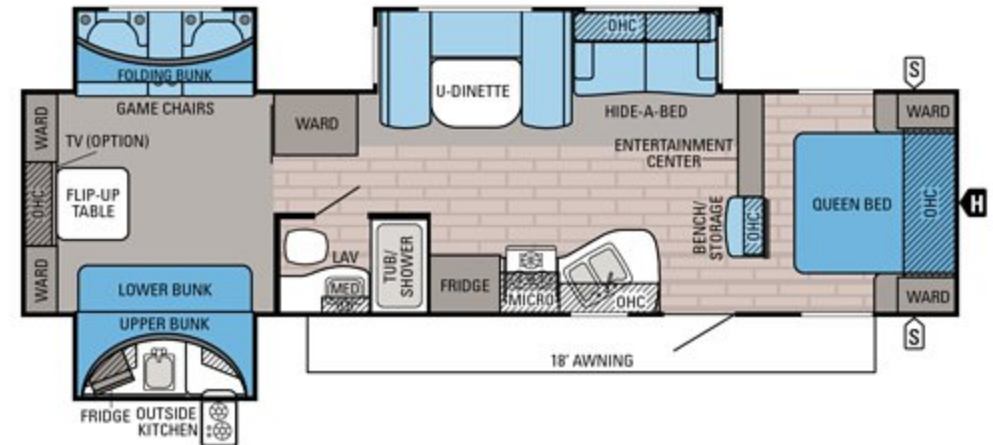

EAGLE TRAVEL TRAILER | 314TSBH OPTION A
Ext. Length: 37' 10" Ext. Height: 138" Unloaded Wt. (lbs.): 8,690 Sleeps: 8-10

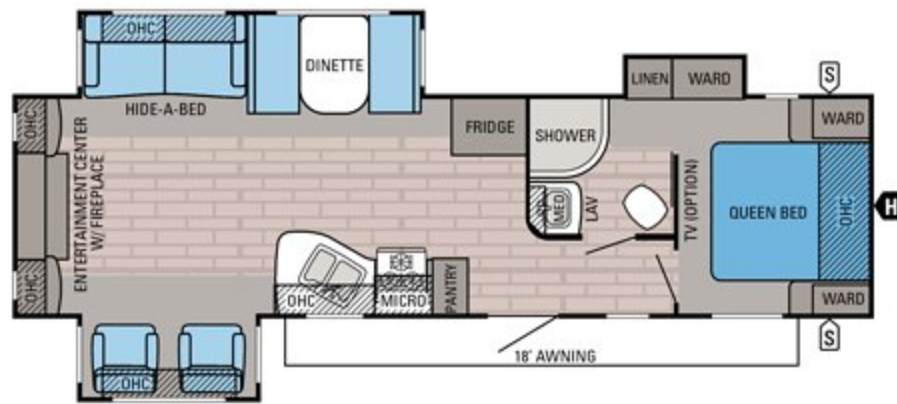

EAGLE TRAVEL TRAILER | 318RETS OPTIONS: A, B
Ext. Length: 35' 3" Ext. Height: 136" Unloaded Wt. (lbs.): 8,080 Sleeps: 4-7

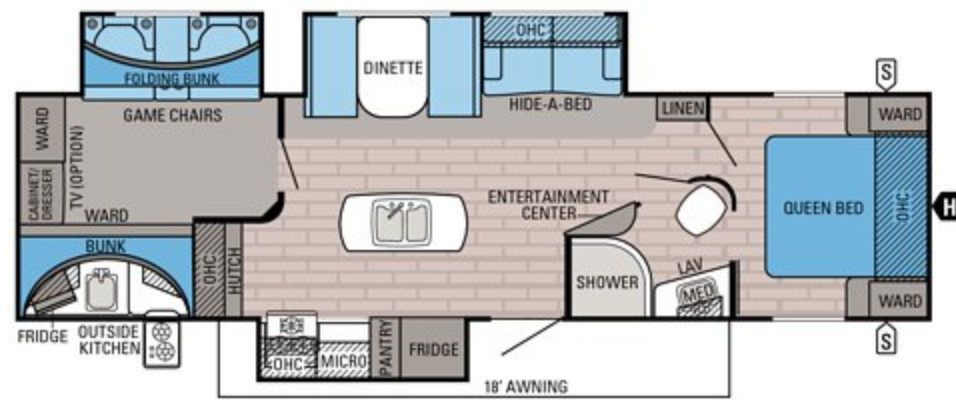

EAGLE TRAVEL TRAILER | 324BHTS OPTIONS: A, C
Ext. Length: 37' 2" Ext. Height: 138" Unloaded Wt. (lbs.): 8,480 Sleeps: 6-7

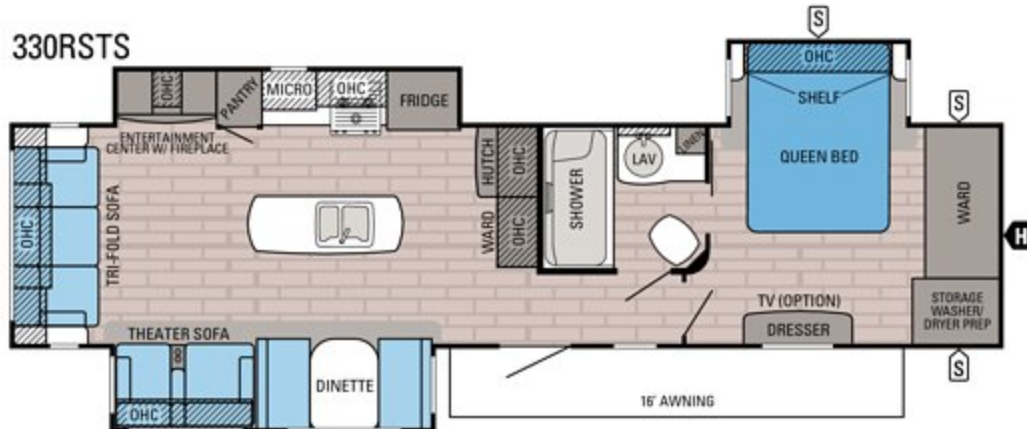

EAGLE TRAVEL TRAILER | 330RSTS OPTIONS: A, D
Ext. Length: 39' 3" Ext. Height: 138" Unloaded Wt. (lbs.): 9,140 Sleeps: 4-6

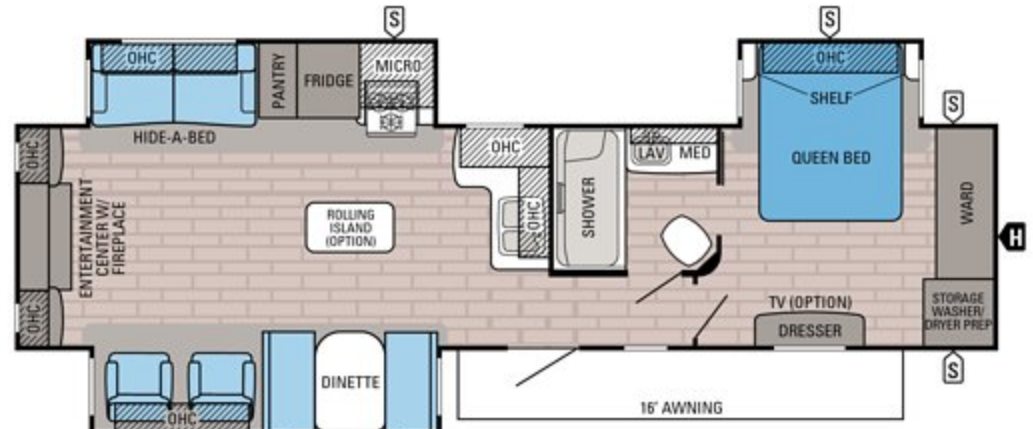

EAGLE TRAVEL TRAILER | 338RETS OPTIONS: A, B, D
Ext. Length: 39' 3" Ext. Height: 137" Unloaded Wt. (lbs.): 9,015 Sleeps: 3-8

EAGLE TRAVEL TRAILER SPECIFICATIONS

MODELS	DIMENSIONS				UNLOADED VEHICLE WEIGHT*	WEIGHT (LBS.)			TANKS (GALS.)		
	EXTERIOR TRAVEL LENGTH	EXTERIOR WIDTH	EXTERIOR HEIGHT (WITH A/C)	INTERIOR HEIGHT		DRY HITCH WEIGHT	GROSS VEHICLE WEIGHT RATING	CARGO CARRYING CAPACITY	FRESH WATER CAPACITY (INCLUDES WATER HEATER)	GREY WASTE WATER CAPACITY	BLACK WASTE WATER CAPACITY
284BHBE	33' 11"	96"	137"	84"	7,015	760	9,250	2,235	81	32.5	32.5
306RKDS	34' 5"	96"	140"	84"	7,535	1,150	9,750	2,215	81	65	32.5
314BHDS	37' 3"	96"	137"	84"	8,110	1,065	9,975	1,865	81	40.5	32.5
314TSBH	37' 10"	96"	138"	84"	8,690	960	10,750	2,060	81	40.5	32.5
318RETS	35' 3"	96"	136"	84"	8,080	945	9,975	1,895	81	32.5	32.5
324BHTS	37' 2"	96"	138"	84"	8,480	1,095	10,950	2,470	81	65	32.5
330RSTS	39' 3"	96"	138"	84"	9,140	1,255	10,950	1,810	81	97.5	32.5
338RETS	39' 3"	96"	137"	84"	9,015	1,210	10,950	1,935	81	65	32.5



314BHDS BUNKHOUSE



314BHDS KITCHEN



314BHDS GAMER SEATS

OPTIONS:

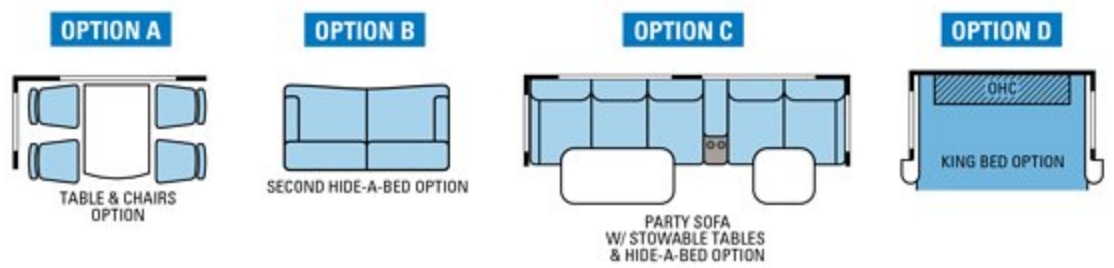

FLOORPLAN KEY:

- S STORAGE
- H TRAILER HITCH
- LAV BATHROOM SINK
- MED MEDICINE CABINET
- MICRO MICROWAVE
- OHC OVERHEAD CABINETS
- FRIDGE REFRIGERATOR
- WARD WARDROBE

*The weights of certain options and/or option packages are not included in the UVW listed in the specification charts.

Unloaded Vehicle Weight (UVW): Sometimes referred to as "Dry Weight," UVW means the typical weight of this trailer as built at the factory. The UVW, as used in product literature and other promotional materials, does not include cargo, fresh water, propane, options or dealer-installed accessories.

Gross Vehicle Weight Rating (GVWR): GVWR means the maximum permissible weight of the trailer, including the UVW plus passengers, personal items, all cargo, fluids, options, and dealer-installed accessories. The GVWR is equal to or greater than the sum of the UVW and the CCC.

Cargo Carrying Capacity (CCC): CCC means the maximum weight of all passengers, personal items, food, fresh water, propane, tools, other cargo and dealer-installed accessories that can be carried by the trailer. CCC is equal to or less than GVWR minus UVW. The addition of options will decrease the CCC.

Hitch Weight (HW): The hitch weight, as used in product literature and other promotional materials, does not include cargo, fresh water, propane gas, options or dealer-installed accessories. The addition of these types of items will either add to or subtract from the stated hitch weight.

It is important for your safety and enjoyment that your tow vehicle be adequately sized and equipped to tow and handle the GVWR of the RV you select. Review weights and rating of your tow vehicle and consult a competent advisor for questions or advice. Whether you are new to RVing or a veteran, get a feel for the performance of your tow vehicle before heading out on the roadways. When you tow an RV, you must drive differently than when you drive a single vehicle. Practice hooking up, driving, backing up and braking in a safe environment or seek out professional instruction. Jayco affixes a weight label to each RV which lists weight information for that vehicle. See specifications chart on previous page.



28.5RSTS INTERIOR SHOWN IN JAVA DÉCOR WITH OPTIONAL SOLID-SURFACE COUNTERTOP



28.5RSTS KITCHEN



28.5RSTS PANTRY AND MUD ROOM WITH SEATING



28.5RSTS BEDROOM WITH DUAL WINDOWS FOR CROSS-VENTILATION

EAGLE HT

With shorter lengths and lighter weights—perfect for towing with today’s half-ton trucks—Eagle HT fifth wheels offer incredible value without sacrificing function or quality. Industry-exclusive standards, including an integrated 2-inch receiver hitch for towing, universal solar prep ports on ground and roof locations, and a rainproof roof vent, prove this lightweight goes heavy on features.



28.5RSTS BATHROOM



REAR INTEGRATED 2-INCH RECEIVER HITCH WITH 300-POUND TONGUE CAPACITY AND 3,000-POUND TOW RATING

EAGLE HT FIFTH WHEEL FLOORPLANS

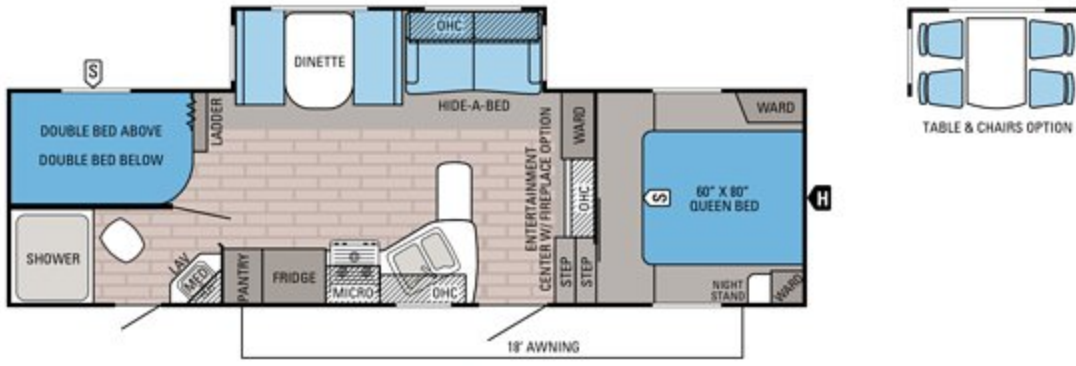

EAGLE HT FIFTH WHEEL | 26.5BHS
Ext. Length: 31' 3" Ext. Height: 150" Unloaded Wt. (lbs.): 7,280 Sleeps: 7-10



EAGLE HT FIFTH WHEEL | 26.5RLS
Ext. Length: 29' 11" Ext. Height: 140" Unloaded Wt. (lbs.): 7,310 Sleeps: 3-6



EAGLE HT FIFTH WHEEL | 27.5RKDS
Ext. Length: 30' 10" Ext. Height: 147" Unloaded Wt. (lbs.): 7,695 Sleeps: 3-4

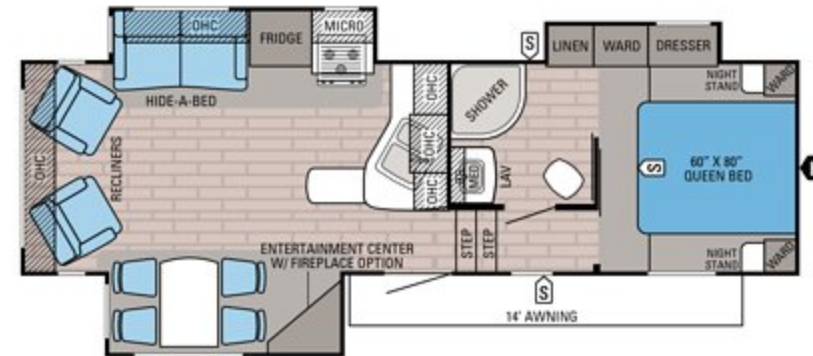

EAGLE HT FIFTH WHEEL | 27.5RLTS
Ext. Length: 30' 11" Ext. Height: 141" Unloaded Wt. (lbs.): 7,880 Sleeps: 3-4

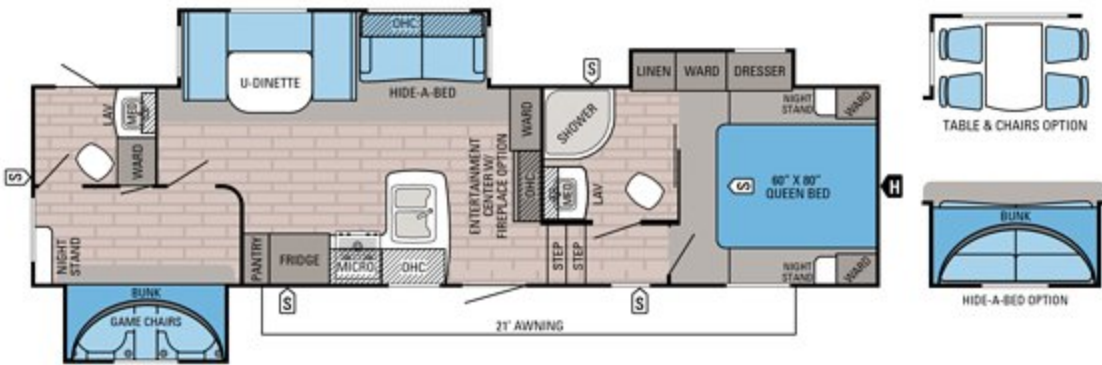

EAGLE HT FIFTH WHEEL | 28.5BHXB
Ext. Length: TBD Ext. Height: TBD Unloaded Wt. (lbs.): TBD Sleeps: 6-9

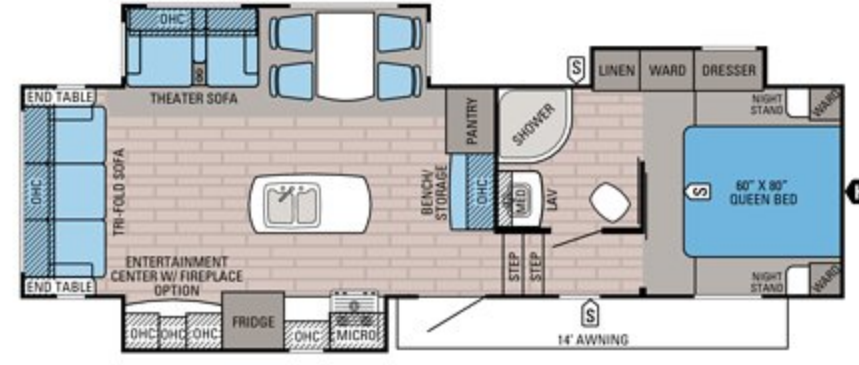

EAGLE HT FIFTH WHEEL | 28.5RSTS
Ext. Length: 32' 10" Ext. Height: 143" Unloaded Wt. (lbs.): 8,340 Sleeps: 4

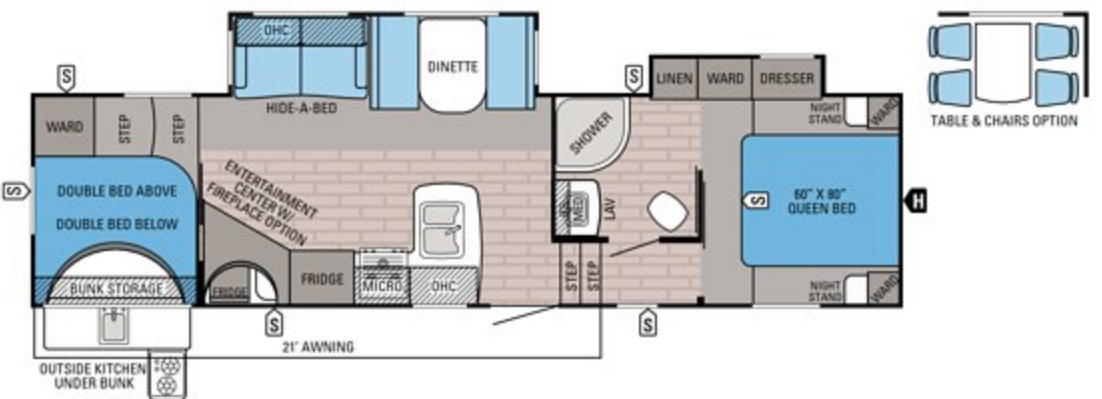

EAGLE HT FIFTH WHEEL | 29.5BHDS
Ext. Length: 34' 7" Ext. Height: 149" Unloaded Wt. (lbs.): 8,375 Sleeps: 7-10

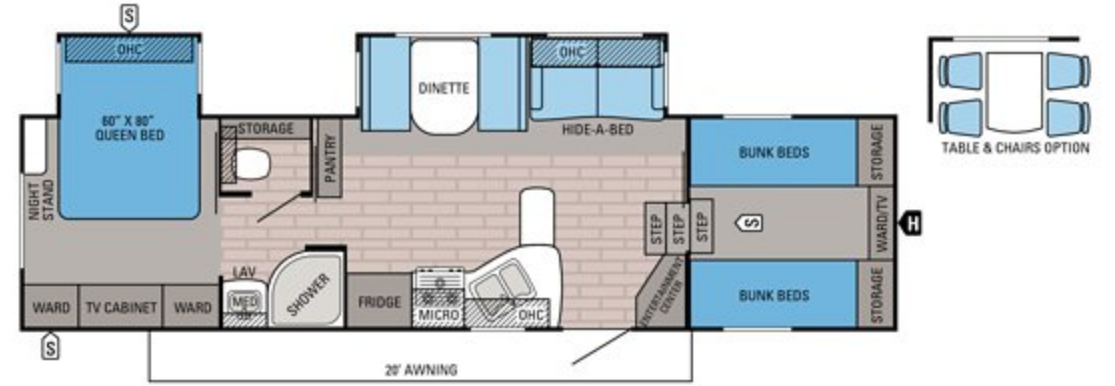

EAGLE HT FIFTH WHEEL | 29.5FBDS
Ext. Length: 34' 4" Ext. Height: 149" Unloaded Wt. (lbs.): 8,130 Sleeps: 7-10

EAGLE HT FIFTH WHEEL SPECIFICATIONS

MODELS	DIMENSIONS					WEIGHT (LBS.)				TANKS (GALS.)			
	FLOORPLAN	TOTAL EXTERIOR LENGTH	EXTERIOR TRAVEL LENGTH*	EXTERIOR WIDTH	EXTERIOR HEIGHT (WITH A/C)	INTERIOR HEIGHT (UPPER DECK)	UNLOADED VEHICLE WEIGHT	DRY HITCH WEIGHT	GROSS VEHICLE WEIGHT RATING	CARGO CARRYING CAPACITY	FRESH WATER CAPACITY (INCLUDES WATER HEATER)	GREY WASTE WATER CAPACITY	BLACK WASTE WATER CAPACITY
26.5BHS		31' 3"	30' 6"	96"	150"	75"	7,280	1,430	9,950	2,670	48	32.5	32.5
26.5RLS		29' 11"	29' 2"	96"	140"	75"	7,310	1,340	9,950	2,640	48	65	32.5
27.5RKDS		30' 10"	30' 0"	96"	147"	75"	7,695	1,410	9,950	2,255	48	65	32.5
27.5RLTS		30' 11"	30' 0"	96"	141"	74"	7,880	1,525	9,950	2,070	48	65	32.5
28.5BHXB		TBD	TBD	96"	TBD	TBD	TBD	TBD	TBD	TBD	TBD	TBD	TBD
28.5RSTS		32' 10"	32' 2"	96"	143"	75"	8,340	1,785	9,950	1,610	49	65	32.5
29.5BHDS		34' 7"	33' 10"	96"	149"	75"	8,375	1,545	9,950	1,575	49	73	32.5
29.5FBDS		34' 4"	33' 8"	96"	149"	75"	8,130	1,600	9,950	1,820	49	65	32.5

*Distance from the pin box to the bumper; total exterior length may be longer.



29.5BHDS INTERIOR SHOWN IN MEADOW DÉCOR



29.5BHDS OUTSIDE KITCHEN



29.5BHDS DOUBLE BUNKS (600-POUND CAPACITY WITH STORAGE BELOW)



325BHQS INTERIOR WITH OPTIONAL PARTY SOFA



355MBQS BATHROOM

EAGLE FIFTH WHEEL

Unique, industry-defining designs and features paired with best-in-class construction set Eagle fifth wheels apart, year after year. From hand-glazed maple cabinetry and hardwood fascias to sunlight-balanced LED lighting and a wireless remote system, Eagle has it all. And an exceptional record to boot: 25 years of innovation, quality and commitment to continuous improvement.



325BHQS BEDROOM WITH 60-INCH X 80-INCH RESIDENTIAL QUEEN DENVER MATTRESS™



325BHQS OUTSIDE KITCHEN



325BHQS INTERIOR WITH OPTIONAL 12-CUBIC-FOOT DOUBLE-DOOR REFRIGERATOR



321RSTS BEDROOM



321RSTS KITCHEN

EAGLE FIFTH WHEEL FLOORPLANS

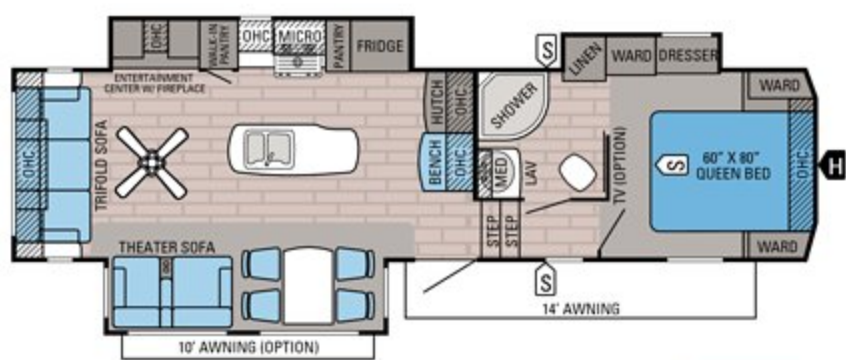

EAGLE FIFTH WHEEL | 291RST | OPTION B
 Ext. Length: 34' 5" Ext. Height: 152" Unloaded Wt. (lbs.): 9,755 Sleeps: 4

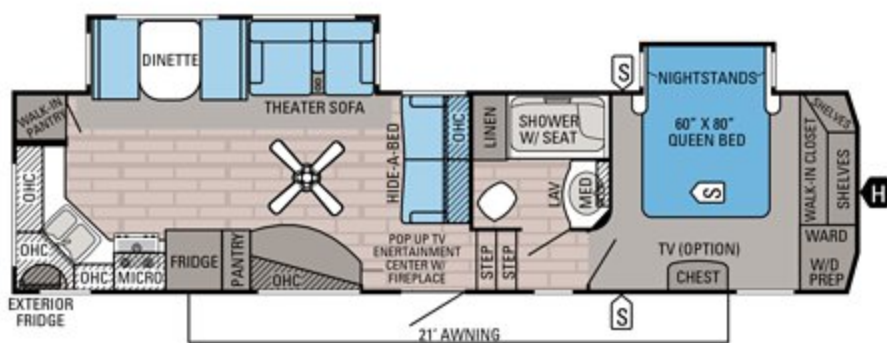

EAGLE FIFTH WHEEL | 293RKD | OPTIONS: A, B
 Ext. Length: 35' 3" Ext. Height: 155" Unloaded Wt. (lbs.): 9,640 Sleeps: 5

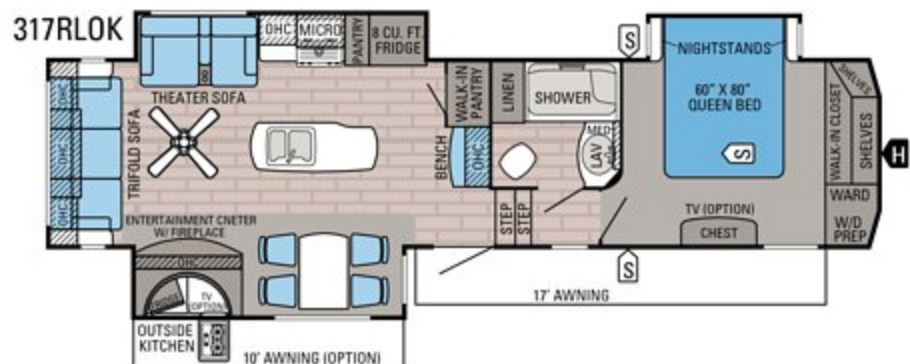

EAGLE FIFTH WHEEL | 317RLOK | OPTION B
 Ext. Length: 37' 0" Ext. Height: 153" Unloaded Wt. (lbs.): 10,325 Sleeps: 4

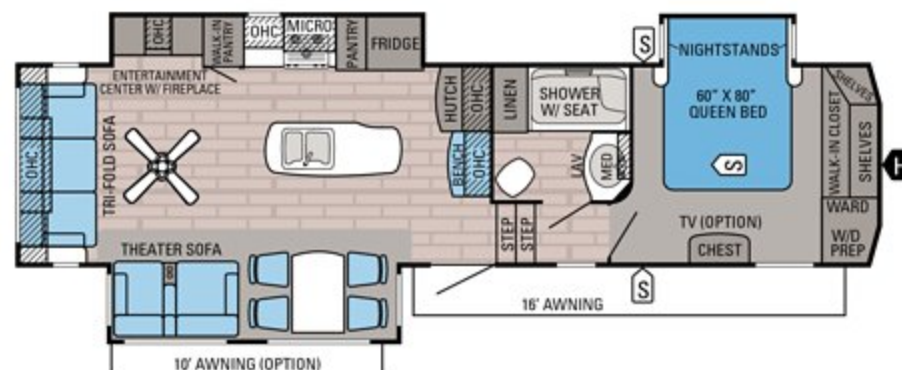

EAGLE FIFTH WHEEL | 321RST | OPTION B
 Ext. Length: 35' 10" Ext. Height: 153" Unloaded Wt. (lbs.): 10,000 Sleeps: 4

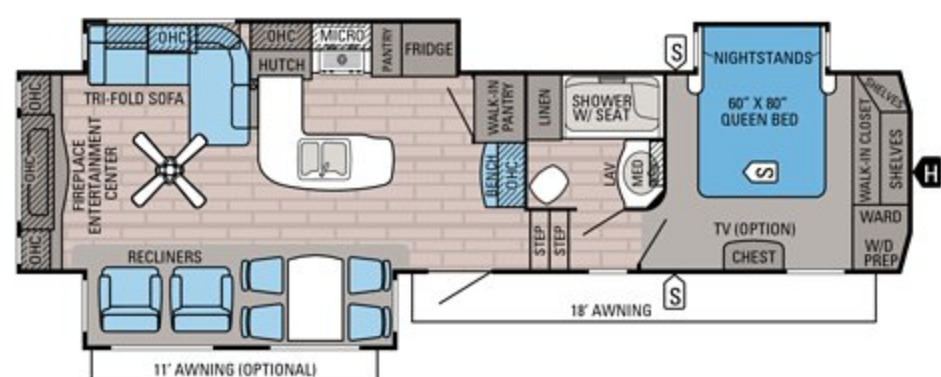

EAGLE FIFTH WHEEL | 323LKT | OPTION B
 Ext. Length: 37' 3" Ext. Height: 152" Unloaded Wt. (lbs.): 10,370 Sleeps: 4

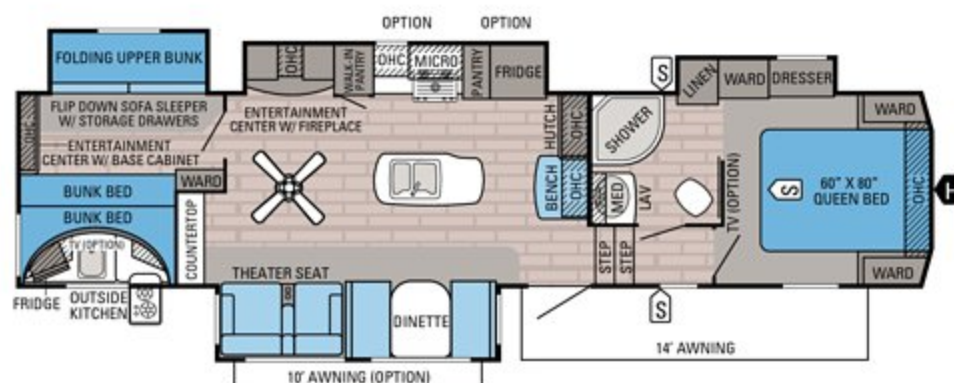

EAGLE FIFTH WHEEL | 325BHQ | OPTIONS: A, B, C
 Ext. Length: 38' 8" Ext. Height: 157" Unloaded Wt. (lbs.): 11,185 Sleeps: 6-8

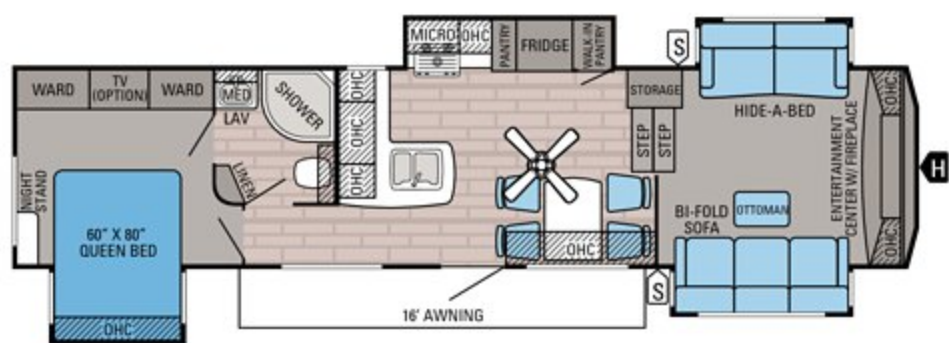

EAGLE FIFTH WHEEL | 339FLQ | OPTION B
 Ext. Length: 37' 8" Ext. Height: 157" Unloaded Wt. (lbs.): 10,125 Sleeps: 5



EAGLE FIFTH WHEEL | 345BHT | OPTIONS: A, C, D
 Ext. Length: 39' 6" Ext. Height: 150" Unloaded Wt. (lbs.): 10,815 Sleeps: 8-10

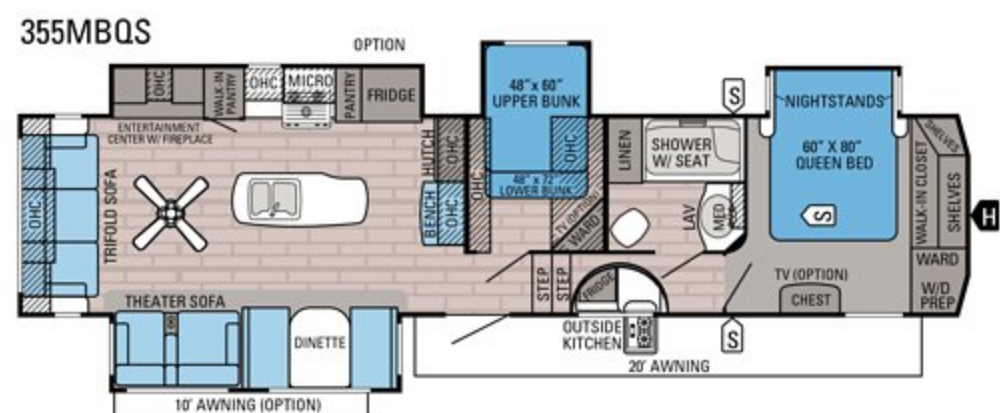

EAGLE FIFTH WHEEL | 355MBQ | OPTIONS: A, B, C
 Ext. Length: 39' 8" Ext. Height: 152" Unloaded Wt. (lbs.): 11,280 Sleeps: 8-10

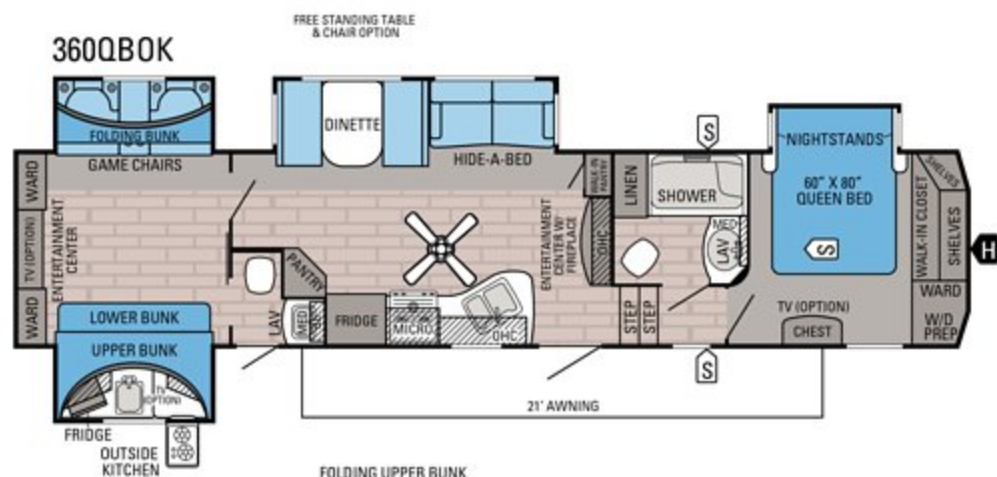

EAGLE FIFTH WHEEL | 360QBOK | OPTIONS: A, C, E
 Ext. Length: 40' 7" Ext. Height: 151" Unloaded Wt. (lbs.): 11,440 Sleeps: 8-11



293RKDS INTERIOR



293RKDS INTERIOR



293RKDS KITCHEN

OPTIONS:

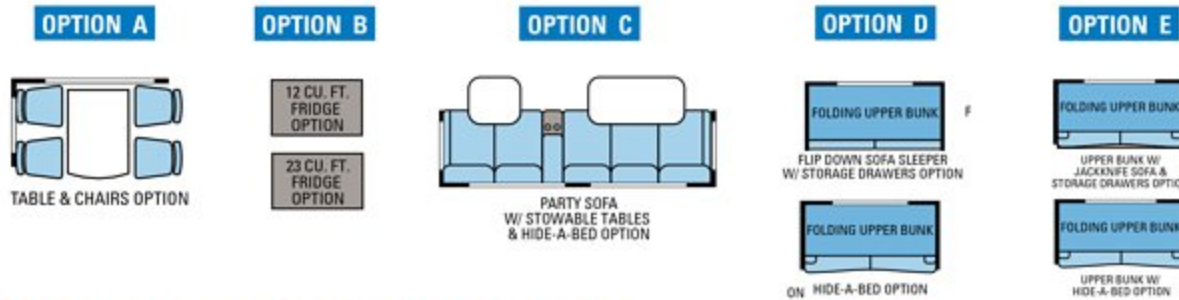

FLOORPLAN KEY:

- S STORAGE
- H TRAILER HITCH
- LAV BATHROOM SINK
- MED MEDICINE CABINET
- MICRO MICROWAVE
- OHC OVERHEAD CABINETS
- FRIDGE REFRIGERATOR
- WARD WARDROBE

EAGLE FIFTH WHEEL SPECIFICATIONS

MODELS	DIMENSIONS						WEIGHT (LBS.)				TANKS (GALS.)		
	TOTAL EXTERIOR LENGTH	EXTERIOR TRAVEL LENGTH*	EXTERIOR WIDTH	EXTERIOR HEIGHT (WITH A/C)	EXTERIOR HEIGHT (WITH OPTIONAL BEDROOM A/C)	INTERIOR HEIGHT (UPPER DECK)	UNLOADED VEHICLE WEIGHT	DRY HITCH WEIGHT	GROSS VEHICLE WEIGHT RATING	CARGO CARRYING CAPACITY	FRESH WATER CAPACITY (INCLUDES WATER HEATER)	GREY WASTE WATER CAPACITY	BLACK WASTE WATER CAPACITY
291RSTS	34' 5"	33' 5"	96"	152"	159"	78"	9,755	1,710	12,000	2,245	81	85	50
293RKDS	35' 3"	34' 5"	96"	155"	159"	78"	9,640	1,825	11,995	2,355	81	87	50
317RLOK	37' 0"	36' 1"	96"	153"	159"	78"	10,325	1,995	12,750	2,425	81	87	50
321RSTS	35' 10"	34' 11"	96"	153"	159"	78"	10,000	1,935	12,500	2,500	81	87	50
323LKTS	37' 3"	36' 4"	96"	152"	159"	78"	10,370	1,890	12,950	2,580	81	87	50
325BHQS	38' 8"	37' 9"	96"	157"	160"	78"	11,185	2,235	13,750	2,565	81	93	50
339FLQS	37' 8"	36' 10"	96"	157"	159"	78"	10,125	1,965	12,600	2,475	81	74	37
345BHTS	39' 6"	38' 9"	96"	150"	159"	78"	10,815	2,080	13,250	2,435	81	95	87
355MBQS	39' 8"	38' 10"	96"	152"	159"	78"	11,280	2,265	13,750	2,470	81	87	50
360QBOK	40' 7"	39' 8"	96"	151"	159"	78"	11,440	1,945	13,750	2,310	81	95	87

*Distance from the pin box to the bumper; total exterior length may be longer.

EDGE ENHANCEMENTS + OPTIONS



HIGH-EFFICIENCY LED LIGHTING

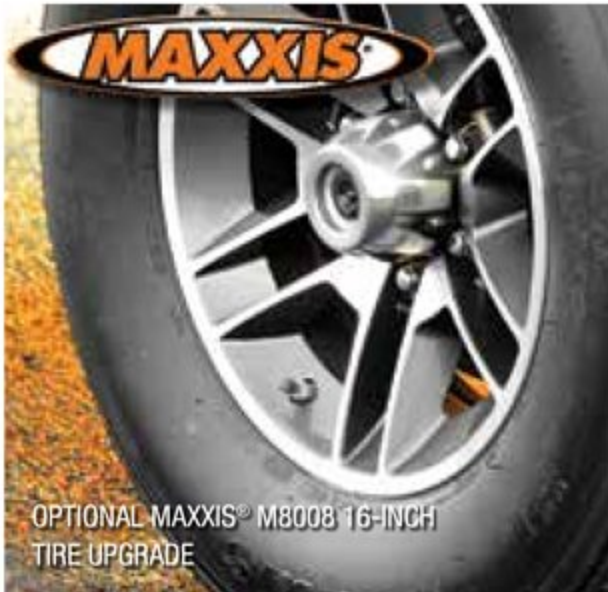

OPTIONAL MAXXIS® M8008 16-INCH TIRE UPGRADE



CUSTOM LED-BACKLIT MIRROR

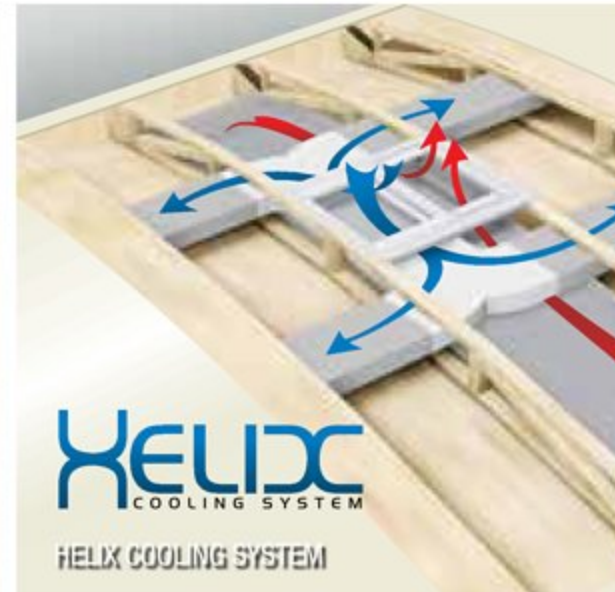

HELIX
COOLING SYSTEM
HELIX COOLING SYSTEM



HI-MACS® BY LG® SOLID-SURFACE KITCHEN COUNTERTOP WITH PULLOUT SPRAYER FAUCET



MORRYDE® CRE3000™ RUBBERIZED SUSPENSION



QUEEN MEMORY FOAM, PILLOW-TOP DENVER MATTRESS



GROUND CONTROL™ 4-POINT ELECTRIC-AUTO-LEVELING SYSTEM WITH HITCH MEMORY



SHAW® RESIDENTIAL CARPETING WITH R2X® STAIN GUARD



POTS AND PANS DRAWER WITH 75-POUND CAPACITY

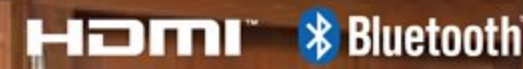

FURRIION DV1200 AV SYSTEM WITH HDMI® AND BLUETOOTH®



INTEGRATED REAR 2-INCH RECEIVER HITCH



SUGAR MAPLE HARDWOOD SLIDE ROOM FASCIA



WASHER/DRYER PREP



GO POWER® ROOFTOP AND GROUND SOLAR PREP



Voyager
EXPAND your vision!
Digital Wireless Observation System
FEATURING **WiSight** technology
OPTIONAL VOYAGER® WIRELESS BACKUP/REARVIEW CAMERA AND MONITOR KIT



LINC® WIRELESS REMOTE CONTROL SYSTEM FOR SLIDE ROOMS, AWNING AND LIGHTING



DUAL USB CHARGING STATION



OPTIONAL REESE® REVOLUTION™ 90-DEGREE PIN BOX



OPTIONAL MORRYDE® "RPB" RUBBER PIN BOX

Eagle Travel Trailer
Eagle HT
Eagle FW

Exterior Equipment	Eagle Travel Trailer	Eagle HT	Eagle FW
I-class cambered structural steel I-beam frame with box-tube steel upper-deck framing	•	•	•
TuffShell™ vacuum-bonded, aluminum-framed, laminated walls (including rear wall and slide room end walls)	•	•	•
High-gloss, gel-coated ivory Filon® fiberglass exterior	•	•	•
Magnum Truss™ Roof System (strongest tested roof in the industry) with one-piece, seamless DiFlex II material	•	•	•
Climate Shield™ zero-degree-tested weather protection: • Fully enclosed and heated underbelly (ducted) • High-BTU output furnace • Double-layer fiberglass batt insulation in ceiling and floor • Double-sided radiant barrier Flexfoil® bubble insulation in roof and slide room floors • PEX plumbing	•	•	•
High-gloss, ivory fiberglass front cap with built-in, recessed LED lighting	•	•	•
Custom automotive-grade 3M® vinyl exterior graphics package	•	•	•
15-inch steel-belted radial tires	•	•	•
16-inch 10-ply, load range 'E' steel-belted radial tires	•	•	•
MOR/ryde CRE3000 rubberized suspension	•	•	•
Power service with detachable Powersmart™ LED shore power cord (Eagle Travel Trailer: 30 or 50 amps depending on model; Eagle HT: 30 amps; Eagle Fifth Wheel: 50 amps)	•	•	•
Cap-integrated, dual 30-pound propane bottles with auto-regulator	•	•	•
Completely enclosed and protected electric slideout mechanisms	•	•	•
NEW: 3-step, extra-sturdy, anti-slip Alumi-Tread™ entrance steps	•	•	•
Oversized entry step with safety light	•	•	•
30-inch x 72-inch entrance door with XL grab handle	•	•	•
NEW: Independent satellite and whole coach cable hookups (a class exclusive)	•	•	•
Digital TV antenna	•	•	•
Exterior marine-grade speakers	•	•	•
Pass-through storage with Slam-latch™ baggage doors	•	•	•
Battery disconnect	•	•	•
Dual-battery capacity	•	•	•
NEW: 6-in-1 sidewall-mounted exterior convenience center (a class exclusive)	•	•	•
Water heater bypass	•	•	•
Black tank flush	•	•	•
Best-in-class fresh water tank sizes	•	•	•
Outside shower	•	•	•
Under-mounted spare tire	•	•	•
Hidden saddlebag storage with lid and restraint netting in pass-through	•	•	•
Outside grill prep	•	•	•
LP quick connect	•	•	•
Roof ladder	•	•	•
NEW: Front and rear electric stabilizer jacks	•	•	•
Electric tongue jack	•	•	•
Triple battery compartment	•	•	•
Heated, enclosed universal docking center	•	•	•
Outside kitchen (select models)	•	•	•
NEW: MAXXIS M8008 16-inch tire upgrade (4 tires, custom aluminum wheels and spare)	•	•	•
MOR/ryde "RPB" Rubber Pin Box	•	•	•
Reese Revolution 90-degree pin box	•	•	•
Outside grill	•	•	•
Thermal-pane, frameless, tinted, safety-glass windows	•	•	•
Rear electric stabilizer jacks	•	•	•
NEW: Voyager wireless backup/rearview camera and monitor kit	•	•	•
Canadian Standards (CSA)	•	•	•
Bike rack/cargo tray	•	•	•
Ground Control 4-point electric auto-leveling system with hitch memory	•	•	•
MOR/ryde EZ Stow toolbox in cargo area (a class exclusive)	•	•	•
Frameless, tinted, safety-glass windows	•	•	•
Machined aluminum rims	•	•	•
NEW: Rooftop and ground solar prep by Go Power (an industry first)	•	•	•
NEW: Rear 2-inch receiver hitch, 300-pound tongue, 3,000-pound tow rating (an industry exclusive)	•	•	•
Rear 2-inch accessory receiver	•	•	•

Optional
 Customer Value Package

Luxury Package

Eagle Travel Trailer
Eagle HT
Eagle FW

Interior Equipment	Eagle Travel Trailer	Eagle HT	Eagle FW
NEW: Solid, hardwood slideout room fascia	•	•	•
3/8-inch tongue-in-groove joined plywood floor decking	•	•	•
NEW: IVC® Trekk™ "Wood Plank" vinyl flooring (standard minimal carpeting)	•	•	•
Shaw residential carpeting with R2X stain guard	•	•	•
NEW: Shaw residential carpet pad with R-value and sound dampening (an industry first)	•	•	•
LED interior lighting throughout	•	•	•
NEW: Central command center with built-in tank monitoring	•	•	•
Tri-fold hide-a-bed sofa with Denver Mattress sleep surface	•	•	•
Swivel glider recliner(s) (select models)	•	•	•
NEW: 32-inch LED HDTV with fully digital HDMI output (a class exclusive)	•	•	•
Wall-hugger theater seating (select models)	•	•	•
Directional and closeable A/C vents	•	•	•
Heavy-duty, 75-pound, full-extension, steel ball-bearing drawer guides	•	•	•
Stainless steel kitchen sink	•	•	•
Residential-style pantry storage	•	•	•
NEW: Stainless steel oven and sealed burner stovetop with hardwood knife rack	•	•	•
8-cubic-foot gas/electric refrigerator with freezer	•	•	•
17.8-gallon-per-hour quick-recovery gas/electric DSI water heater	•	•	•
NEW: Dual USB charging ports (kitchen and bedroom)	•	•	•
NEW: 12V charging station	•	•	•
Pleated window shades	•	•	•
NEW: Hardwood safety handrail on steps (all fifth wheel models, select HT models)	•	•	•
NEW: Radius door XL shower with ABS tile-look tub surround (select models)	•	•	•
Bath skylight	•	•	•
NEW: LED vanity and residential-size mirror (an industry exclusive)	•	•	•
NEW: Bathroom stone backsplash	•	•	•
Residential-style shower with sliding glass door (up to 48 inches)	•	•	•
Porcelain foot-flush toilet	•	•	•
NEW: Residential quilted bedspread and pillows	•	•	•
Carbon monoxide and LP detector	•	•	•
Extra 110V power outlets in kitchen and slide rooms	•	•	•
Built-in "mud room" bench locker/coat storage (a class exclusive, n/a 293RKDS, 317RLTS, 339FLOS, 345BHQS)	•	•	•
NEW: Handcrafted, Sugar Maple-glazed, maple cabinetry and drawers	•	•	•
NEW: Brushed nickel kitchen faucet with pullout sprayer	•	•	•
NEW: Second tri-fold hide-a-bed sofa with Denver Mattress sleep surface (select models)	•	•	•
Sleeper sofa (replaces J-Cube futon on 345BHQS, 360QBOK; standard on 325BHQS)	•	•	•
NEW: Party sofa with stowable tables and hide-a-bed in place of booth and theater seating (324BHQS, 325BHQS, 345BHQS, 355MBQS, 360QBOK)	•	•	•
NEW: 24-inch LED TV (bunkhouse, select models)	•	•	•
NEW: 24-inch LED TV (outside kitchen, select models)	•	•	•
NEW: 32-inch LED TV (master bedroom, select models)	•	•	•
50-amp service with dual A/C ducting and second A/C prep (standard on select travel trailer models)	•	•	•
Second A/C in bedroom (15,000 BTU; requires 50-amp service)	•	•	•
King pillow-top memory foam Denver Mattress with under-bed storage	•	•	•
Second power awning (a class exclusive, 291RSTS, 317RLOK, 321RSTS, 323LKTS, 325BHQS, 355MBQS)	•	•	•
12-cubic-foot refrigerator (n/a 345BHQS, 360QBOK)	•	•	•
NEW: Free-standing Sugar Maple table with leaf, built-in storage, 2 folding chairs (standard on select fifth wheel models)	•	•	•
23-cubic-foot residential refrigerator with 1,000-watt inverter (n/a on 345BHQS, 360QBOK)	•	•	•
Rolling island pantry (338RETS)	•	•	•
Second tri-fold hide-a-bed sofa (bunkroom) (select models)	•	•	•
NEW: LED fireplace, 5,000-BTU electric heater (select models)	•	•	•
HI-MACS solid-surface kitchen countertop by LG® with pullout sprayer kitchen faucet and flush-mount sink covers (standard on select travel trailer models)	•	•	•
NEW: Washer/dryer prep (select models)	•	•	•
NEW: 39-inch LED HDTV with fully digital HDMI output (48-inch in 339FLOS)	•	•	•
110V ceiling fan	•	•	•
NEW: Linc wireless remote control system	•	•	•
NEW: 12V AM/FM/CD/DVD/USB 3-zone A/V system with Bluetooth and HDMI	•	•	•
13,500- or 15,000-BTU dual-ducted Whisper-Quiet A/C system (a class exclusive)	•	•	•
15,000-BTU dual-ducted Whisper Quiet A/C system (a class exclusive)	•	•	•
NEW: Stainless steel microwave with exhaust fan	•	•	•
NEW: Rain-proof EZ Breeze™ 350CFM bathroom power vent (patent pending, a class exclusive)	•	•	•
Queen pillow-top memory foam Denver Mattress with under-bed storage	•	•	•
Electric patio awning with integrated LED lights	•	•	•

LET'S JAYCO—AND LEAVE OUR WORRIES BEHIND.

We know that your family fun rides on our commitment to quality. So we go the extra mile to make products that last—and stand behind them longer than anyone in the business.



JAYCO'S ROOF **VS** OTHER ROOFS

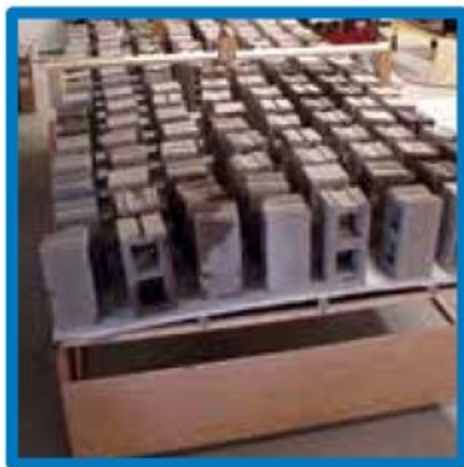

4,500 POUNDS ON A JAYCO ROOF VS. OTHER ROOFS

THE MAGNUM TRUSS ROOF SYSTEM **50 percent stronger**



CLIMATESHIELD

THE JAYCO DIFFERENCE

When you go with Jayco, you get the strongest foundation in the business, unmatched weatherproofing and rock-solid construction.

- 1. Vacuum-bonded walls, floors and roof** for better protection from the elements
- 2. Magnum Truss Roof System** withstands 4,500 pounds—50 percent more than other roofs
- 3. Welded aluminum frame** for a durable, lightweight structure
- 4. Double layer of fiberglass insulation** behind the front cap, plus Flexfoil and fiberglass insulation in the floor to provide extra warmth where it's needed most—in the bedroom
- 5. Aerodynamic front cap** withstands the rigors of the road with infused pigment and gel coating, plus ¼-inch plywood bracing for additional support—not typically found on competing fifth wheels



Extend your camping season with the Jayco Climate Shield

It protects against extreme heat and extreme freezing—even in temperatures as high as 100 degrees or as low as zero degrees (Fahrenheit).*

*Eagle was tested in zero degrees F and 100 degrees F weather over an extended period of time in a controlled environment and all functions of the coach were fully operational. Testing was done in a completely controlled environment; therefore, temperatures during testing may not represent actual temperatures in nature, and cannot account for elements such as wind or moisture. In actual use, unit may not perform as well. Supplier of cooling components does not guarantee anything better than 20 degrees difference from ambient temperature. In addition, outside components are subject to freezing and require steps to properly insulate. Jayco's warranty does not cover damage caused by freezing. To learn more about Climate Shield and testing done by Jayco, visit www.jayco.com.

WE START WITH ONE OF THE INDUSTRY'S **strongest** foundations

Many competitors modify or weld stock frames, which can weaken the integrity of your foundation. Jayco's custom-manufactured frames offer higher strength and durability.

Full-width outriggers: We build on full-width outriggers that are spaced 4-6 feet apart (vs. 8 feet) to better support the weight of the wall.

4-6 ft.

Eagle travel trailer integrated A-frame: The A-frame runs through the main frame, preventing the hitch from buckling—a common issue in competing tack-welded frames.

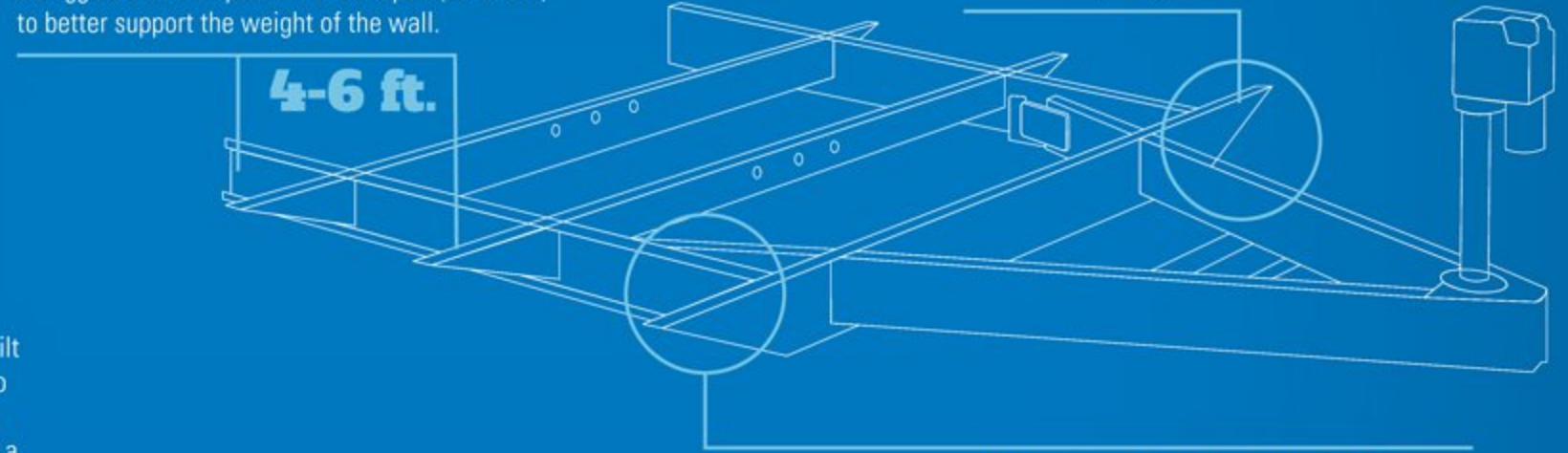

Fifth wheel frame: The frame over the truck bed is built on a superior 2-inch x 6-inch tube perimeter structure to better support the bedroom sidewalls. Competing fifth wheels have a smaller frame; these manufacturers add a sidewall support seam to compensate for expansion joints.

2" x 6"

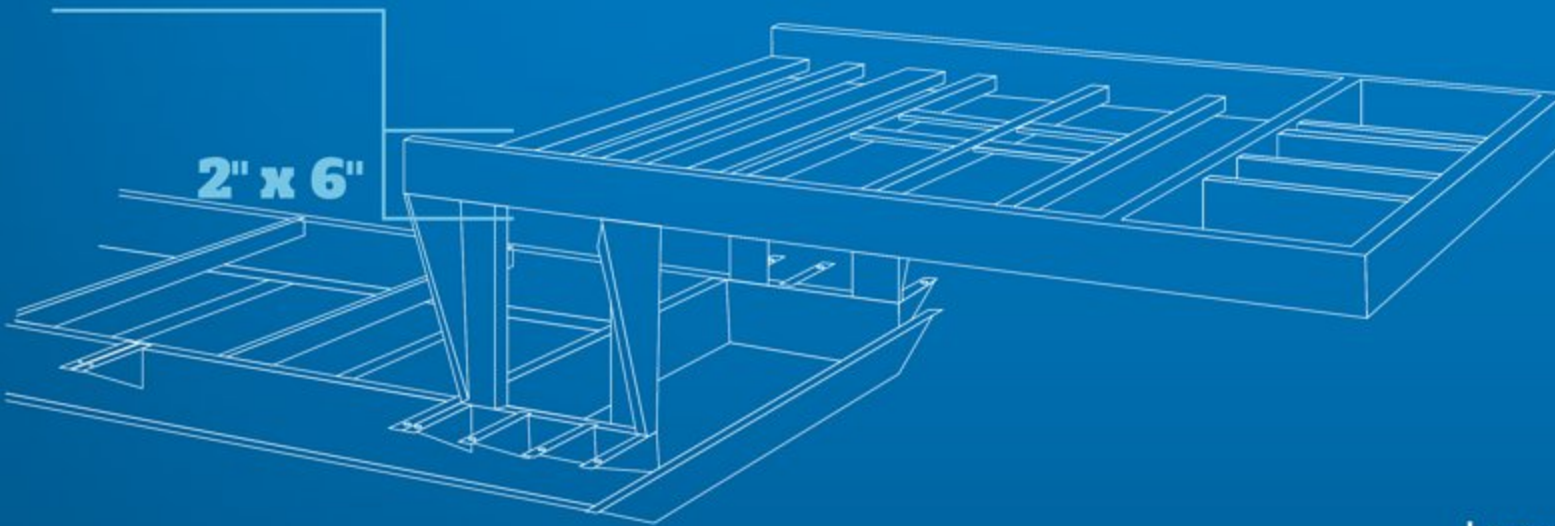

I-class cambered structural steel I-beams: Jayco uses a unique molded, one-piece design to prevent the unit from twisting; competing three-piece I-beams can warp over time at the welded seams.

Learn more at StrongFoundation.Jayco.com

EAGLE INTERIOR DECOR

ALMOND



HAVANA



JAVA



MEADOW

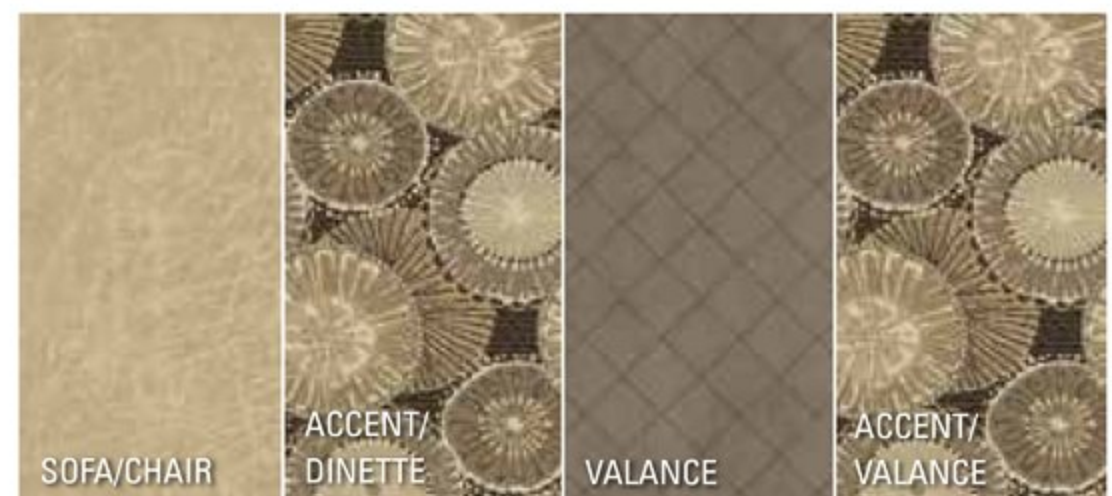



2
YEAR
WARRANTY

FREE

ROADSIDE
ASSISTANCE

Travel with confidence, with our industry-leading, 2-year limited warranty and a year's access to Coach-Net™—the country's largest RV emergency road service.



Jayco's industry-leading 2-year limited warranty*

*For a copy of our 2-year limited warranty with full terms and conditions, please contact your local Jayco dealer.



DSI award-winner—8 years and running

With 25 years of customer satisfaction, Jayco's Eagle brand is the longest-running, most successful fifth wheel on the market today. This past award season, Eagle received the prestigious Quality Circle Award for the eighth year in a row! The award, based on a survey of hundreds of RV dealers in the U.S. and Canada, takes into account product quality, value, service/support and more.

eco advantage™

Jayco's long-term commitment to generations of family fun

After four years of increased efforts to eliminate waste, conserve energy and increase recycling, we've come a long way in building RVs that are not only better for your family—but also better for the planet. **Learn more at Jayco.com/EcoAdvantage**

Meet your Jayco Dealer



We work hard—so you can play hard. From finding the perfect Jayco for your family to providing flexible financing options and full-service support, we're here to help.

Follow Jayco



Jayco, Inc., P.O. Box 460, Middlebury, IN 46540, www.jayco.com © **RVIA** See dealer for further information and prices. All information in this brochure is the latest available at the time of publication approval. Jayco reserves the right to make changes and to discontinue models without notice or obligation. Photos in this brochure may show optional equipment and props for photography purposes. RVs built for sale in Canada may differ to conform to Canadian codes. ©2015 Jayco, Inc. 15-FDCT-PL 1115-15k Printed in U.S.A.